

Infusion Bench

111-BC-60



Furniture that makes a difference.

Product Description

Infusion Bench

111-BC-60

Style: Infusion, Lounge

Model: 111-BC-60

Dimensions

W	D	H	SW	SD	SH	DW	DD	DH	COM	WT Cap
60"	22.5"	32.5"	55"	17"	18.5"	24"	16"	3"	yds	550lbs

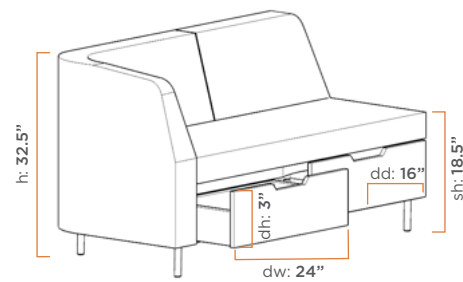
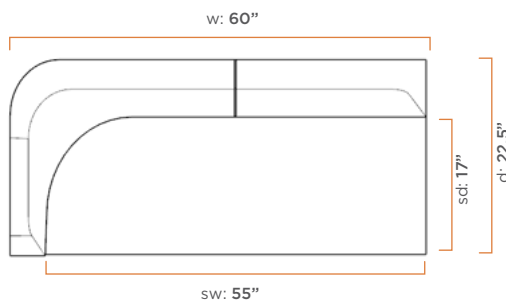

Design Features

- Small scale footprint
- Comfortable seating for patient visitors
- Optional storage drawers
- Designed for family-centered care
- Unique bench designed for infusion care
- Available in custom dimensions

Performance & Environmental Sustainability

- 550 lb capacity
- HHI Compliant
- 12 Year Warranty
- Air Quality Certification BIFMA

Options

4088WDR Single drawer heavy duty ball bearing glides

CURVED LINES FOR COMFORT

OPTIONAL DRAWERS

FAMILY CENTERED CARE

SMALL SCALE FOOTPRINT



Materials

Powdercoat

Legs



Black Powdercoat



White Powdercoat

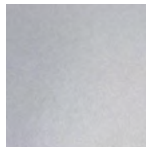

Wheel Silve Powdercoat



Silver Metallic Cardinal GR1342

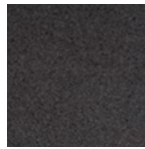

Special Grey Cardinal GR494



Bronze Hammer Cardinal BR161

*Custom Powder Coated Steel Available

Laminate

Drawer Fronts

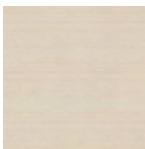

Asian Sand 7952K-18

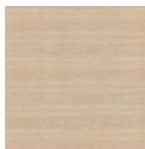

Beigewood 7850-60

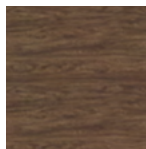

Mangalore Mango 7974-38

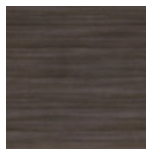

Skyline Walnut 7964K-12

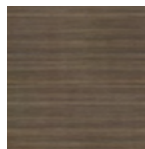

Studio Teak 7960K-18

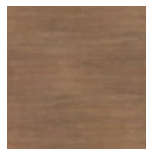

River Cherry 7937-38

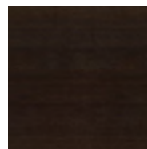

Cafelle 7933K-07

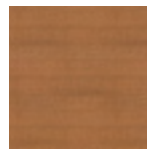

Huntington Maple 7929-38